

Article number: 20194B48B482BL

Description: E+G  
T-angel clamps GN194-B48-B48-2-BL

## Measures

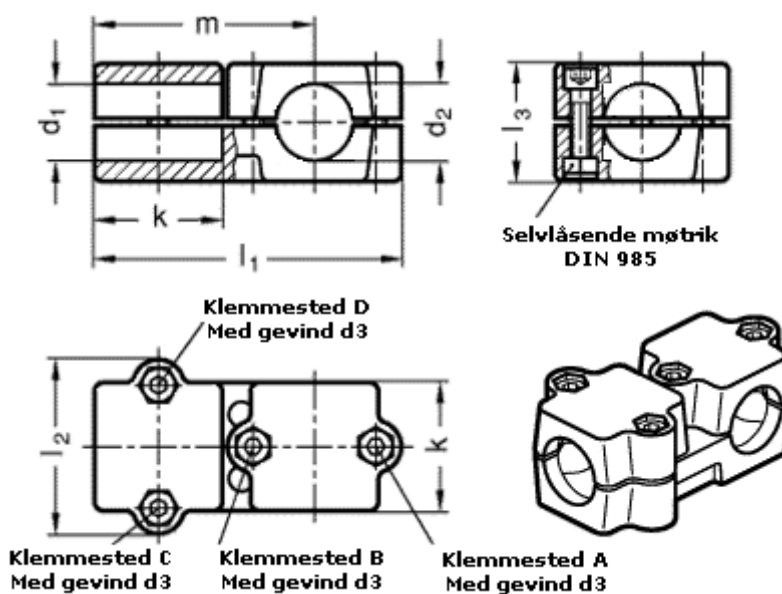

d1 = 48  
d2 = 48  
d3 = M10  
k = 76  
l1 = 176  
l2 = 98  
l3 = 70  
m = 126